

INSTRUCTIONS FOR USE

The Pink Pad[®] Air-Assist

For Use In Trendelenburg & Reverse Trendelenburg

DESCRIPTION:

The Pink Pad Air-Assist is a single use system for use in surgical procedures.

PRIOR TO USE:

Visually inspect both sides of the Pink Pad Air-Assist. Products used for Trendelenburg or Reverse-Trendelenburg positioning MUST feature PinkProtect™ (pink in color) materials on both top and bottom surfaces.

INDICATIONS

- Patients who will be put into the Trendelenburg (or Reverse Trendelenburg) position with or without Lithotomy or Tilt.
- Patients who are unable to assist in lateral transfer, repositioning and / or boosting.
- Patients whose weight or girth poses a potential health risk for the caregiver(s) responsible for repositioning and/or laterally transferring said patient.

INTENDED USE:

The Pink Pad Air-Assist is a non-sterile single-use device intended for all surgical procedures where a patient may be placed in Trendelenburg (or Reverse Trendelenburg) up to 35 degrees, including with use of robotics. Patient transfer / repositioning / boosting can be facilitated before and / or after the procedure where the patient's weight might place staff at risk for injury. The Pink Pad Air-Assist is designed to securely hold a patient in varying degrees of Trendelenburg, up to 35 degrees. This device can ease the patient transfer from pre-op to the O.R. Table, and following the procedure from the O.R. Table to PACU. The patient transfer system safely positions high BMI patients while protecting against HAPI formation and nerve damage during surgery.

The Pink Pad Air-Assist features a skin friendly design that supports an ideal microclimate allowing the product to stay under patients during surgery.

CONTRAINDICATIONS

This device is not designed, sold, or intended for use except as indicated.

KNOWLEDGE AND INTENDED SETTING

Device intended for use by trained healthcare personnel. Device use limited to surgical setting and operating room in a hospital or surgery center.

CLINICAL BENEFITS:

To aid hospital facilities in providing a safe and effective method of management of the patient for pressure ulcers and non-movement for patients in the Trendelenburg position.

INTENDED USER

This device is intended for use by trained healthcare professionals only.

INTENDED CARE SETTINGS

Hospitals and Ambulatory Surgery Centers (ASC).

PRECAUTION

- The Pink Pad Air-Assist should be used in accordance with the instructions for use and any contraindications, warnings or precautions provided by the manufacturer of the associated instrument.
- Before using Pink Pad Air-Assist, ensure that the O.R. table pad is securely affixed to the O.R. table and is clean and free of residue.
- Be sure to follow your facility's policies and guidelines for frequency of patient monitoring. Check skin for integrity and proper circulation. Product is to be used by licensed medical professional only.
- Care should be taken to safeguard The Air-Assist from exposure to prep solutions.
- Healthcare personnel must verify that all caster brakes have been engaged prior to transfer.
- Use a minimum of three healthcare personnel during air-assisted lateral patient transfers.
- Never leave the patient unattended when the device is inflated.
- Use this product only for its intended purposes, as described in this manual.
- Only use attachments and/or accessories that are authorized by Xodus Medical.
- Never attempt to transfer a patient on an uninflated Pink Pad Air-Assist.
- Follow hospital protocol for safe disposal of product following use.
- The Pink Pad Air-Assist is designed to work with most common patient transfer blowers, before use, please consult your local Xodus Medical representative, or email info@xodusmedical.com to confirm compatibility with the Air-Assist.

*WARNINGS:

- Prior to moving a patient into a Trendelenburg (or Reverse Trendelenburg) position, ensure that the Air-Assist is deflated and secured to the O.R. Table per instructions.
- Before use, make sure the air hose is securely fastened in the Pink Pad Air-Assist inlet
- Air-Assist Power Lift is not for use in the presence of flammable anesthetics or in a hyperbaric chamber or oxygen tent.
- Route the Air-Assist Power Lift power cord in a manner to ensure freedom from hazard.
- Avoid blocking the air intakes of the Air-Assist Power Lift.
- Avoid electric shock. Do not open Air-Assist Power Lift container.
- This device was designed, test and manufactured for single patient use only. Reuse or reprocessing of this device may lead to its failure or subsequent injury.
- Reprocessing of this device may create the risk of contamination and patient infection.
- Do not reuse or reprocess this device.
- Follow Air-Assist Power Lift IFU for correct usage.
- Please visually inspect for breaches of packaging integrity prior to use. Do not use if damaged, opened, or breached.
- Power Lift Unit must be turned-off prior to the start of the procedure.
- Do not operate Power Lift Unit intraoperatively.
- **Notice to the User and/or patient that any serious incident that has occurred in relation to the device should be reported and the competent authority of the Member State in which the user and/or patient is established, as well as Xodus Medical and its Authorized Representative.**

DISPOSAL

After use, the Pink Pad® Air-Assist should be disposed of in accordance with hospital policy.

TECHNICAL SPECIFICATIONS:

- Materials of manufacture include:
 - » Polyurethane foam, synthetic adhesive, nylon material and strap
- Shelf Life – indefinite

STORAGE, TRANSPORT, AND OPERATIONAL CONDITIONS

- The Pink Pad Air-Assist should be stored in a clean, dry location at room temperature prior to use. Avoid prolonged exposure to elevated temperatures.
- During ALL handling and storage, assure that the pad is flat. Do not roll or fold the pad.

ATTENTION

- To avoid unwanted movement healthcare personnel must position themselves on either side of the patient at all times during positioning and repositioning.
- Red handles are designed to move the Air-Assist and patient when the system is inflated

BLACK AND WHITE STRAPS ON EITHER SIDE OF THE PINK PAD MUST BE SECURED TO OPERATING ROOM TABLE RAILS PRIOR TO PROCEDURES.

PREPARATION AND USE

PATIENT TRANSFER

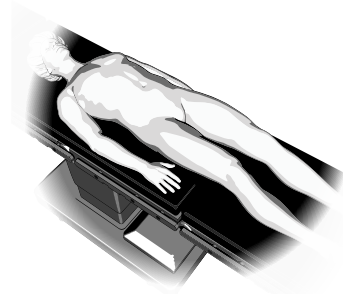

Figure A

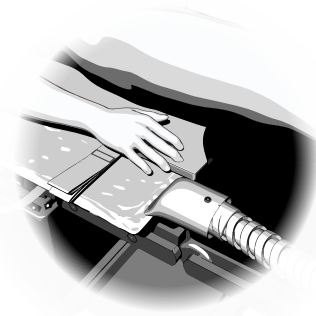

Figure B

1. Patient should preferably be in a supine position.
2. When transferring a patient from a bed surface to an OR table surface: Place the Air-Assist underneath patient using a log-rolling technique and secure body strap without over tightening. Lower the bed rails following inflation and prior to transfer.
3. When transferring a patient from an OR table surface to the bed surface, assure Air-Assist is centered under the patient prior to inflation. Raise bed rails following transfer of patient and deflation of Air-Assist.
4. Insert the hose nozzle into either of two hose entries at the foot end of the Air-Assist and snap into place. (*Refer to Figure B*)
5. Plug the Air-Assist Power Lift power cord into an electric outlet.
6. Ensure that transfer surfaces are as close as possible and lock all wheels.
7. If possible, transfer from a higher surface to a lower surface.
8. Turn on the Air-Assist Power Lift.
9. With the Air-Assist fully inflated and a healthcare personnel on each side of the Air-Assist and one located at the foot-end, use the red handles of the Air-Assist to push or pull the Air-Assist at an angle, either head-first or feet-first. When halfway across separate surfaces, opposite caregiver should grasp closest red handles and pull to desired location. Ensure healthcare personnel at foot end guides patient's feet during the transfer. (*Refer to Figure C, D, E*)
10. Ensure the patient is centered on receiving equipment prior to deflation.
11. Turn off the Air-Assist Power Lift. This will deflate the mattress (if transferring to a stretcher, raise the bed/stretcher rails).
12. Disconnect the air hose from the Air Assist.
13. Secure mattress to OR table using black & white straps.

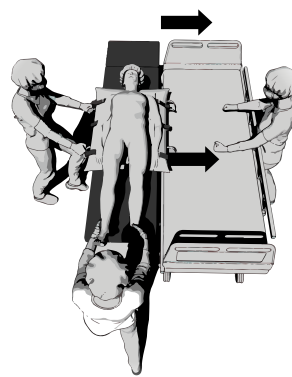

Figure C

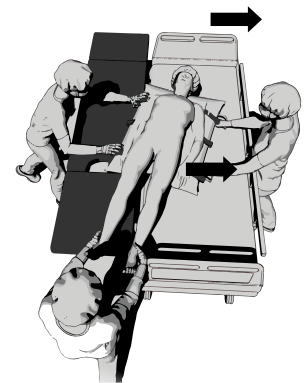

Figure D

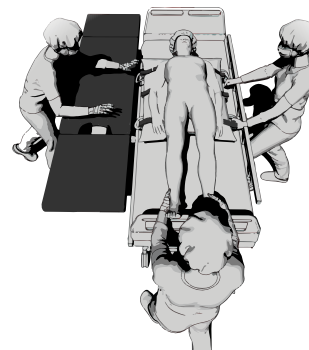
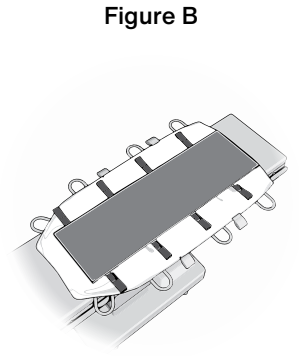
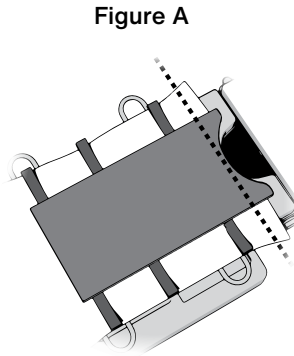

Figure E

TRENDELENBURG POSITIONING

- Place The Pink Pad Air-Assist at the very edge of the middle table segment nearest the perineal cutout, positioning the white hook & loop straps on the underside of The Pink Pad in direct contact with the table pad's surface. *Figure A*
Place the Pink Pad Air Assist EXT and EXT+ Trendelenburg on the OR table, centered as needed, positioning the white hook & loop straps on the underside of The Pink Pad in direct contact with the table pad's surface. *Figure B*



IMPORTANT: DO NOT use any table covers, linens, other transfer devices or materials between The Pink® Pad and surface of the surgical table. The Pink Pad must contact the surface of the table pad. The "This Side Up" tags should be facing upward.

- Attach the white and black hook & loop straps of The Pink Pad Air-Assist to the surgical table rails by looping under the rail,** as shown, and affixing the ends of the hook & loop to each other. Make sure to position the strap at a table rail mounting post in a "figure eight" configuration to have the strap in front of and behind the table rail mounting post, if possible.

Figure C

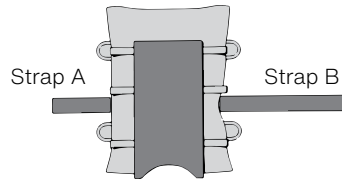
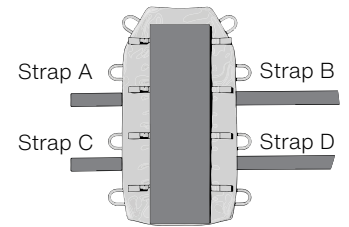

Figure D



- Lay the lift sheet over the pad, centered between the hook & loop strap. The lift sheet should cover only the portion of the pad that will be addressing the small of the patient's back - below the Scapula Region and above the Sacrum.

- Follow hospital protocol for intubation. Then properly position patient on pad.

- IMPORTANT - THE PATIENT'S SKIN MUST MAKE DIRECT CONTACT WITH THE PINK PAD.** The skin of the Scapula Region and Sacrum must contact the pad surface. Utilize the included lift sheet to carefully lift the patient up and off the pad to reposition as needed. Do not drag patient on pad. Make sure pad remains completely flat at all times.

- Tuck arms as shown or per hospital protocol.

- Attach the body strap as follows:

- Make sure the patient is center aligned on the Air Assist.
- Place Strap A over the patient's body.
- Place Strap B across the patient's body, connecting to the hook & loop patch on Strap A.
- Fold the excess from Strap B, back onto itself attaching to the small hook and loop square.

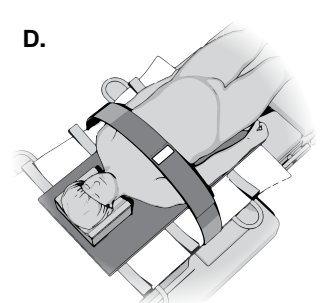
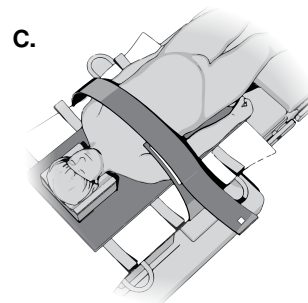
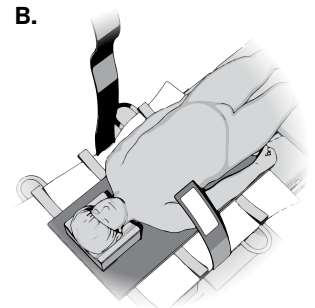
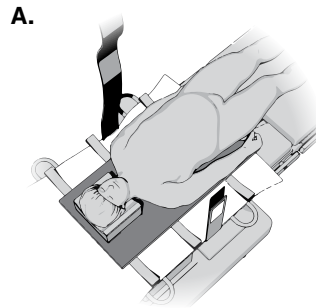

ATTENTION:

- Before using The Pink Pad Air-Assist, ensure that the O.R. table pad is securely affixed to the O.R. table and is clean and free of residue
- Be sure to follow your facility's policies and guidelines for frequency of patient monitoring. Check skin for integrity and proper circulation. Product is to be used by licensed medical professional only.
- Care should be taken to safeguard The Pink Air-Assist from exposure to prep solutions.
- Handling & Storage: During ALL handling and storage, assure that the pad is flat. Do not roll or fold the pad.

1.



2.



3.

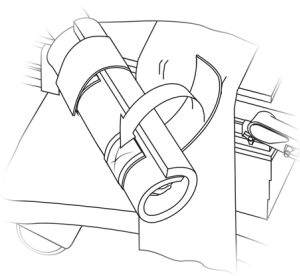

4.

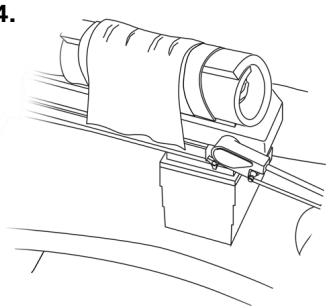

ONE-STEP ARM PROTECTORS

1. Place the One-Step™ Arm Protector beneath the patient's arm, centering the arm protector laterally with straps facing down and inward toward the patient's torso.

The pad should extend above the elbow and just below the fingertips. The hand should be positioned in a natural anatomical position with the palms facing inward so as not to impinge upon the ulnar nerve.

The One-Step™ will protect the arm, ulnar nerve and fingers when adjusting the leg stirrups, while permitting easy access to the fingers and IV site. It will also safeguard against tissue breakdown.

2. Wrap the outer portion of the protector over the arm.
3. Next, wrap the remaining portion of the arm protector over the arm and secure the straps to the corresponding Hook & loop patches as shown. Ensure that the One-Step™ Arm Protector is firmly wrapped around the patient's arm.

At this stage, check for proper alignment of the wrist and fingers. Also, inspect pulse oximeters, IV lines, etc. to ensure proper placement. Accessing these patient monitors is simple and repeatable.

4. Repeat steps 1-3 for the remaining arm. Once the One-Step™ protectors are in place, wrap the lift sheet per hospital protocol, tucking it between the patient and The Pink Pad®.

Tucking methods vary according to hospital protocol. Lift sheets should not be tucked between The Pink Pad® and the O.R. table mattress.



Do Not Re-use



Non-sterile



Medical Device



xodusmedical.com/eifu

Consult instructions for use or consult electronic instructions for use



Caution, Consult Accompanying Documents



Not Made with Natural Rubber Latex



Do Not Use If The Package Is Damaged Or Opened

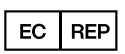

Emergo Europe
Westervoortsedijk 60
6827 AT Arnhem
The Netherlands



XODUS MEDICAL
Making Surgery Safer™

702 Prominence Drive
New Kensington, PA 15068,
United States

xodusmedical.com
info@xodusmedical.com
Tel: 1+724-337-5500

FDA REGISTERED
ISO 13485 CERTIFIED



MADE IN THE
USA

LITIFUAA001 R3 3/12/2024