

Air-Assist Power Lift

Instructions for Use

INTENDED USE:

The Pink Pad Air-Assist is intended for all surgical procedures where a patient may be transferred from pre-op to the O.R. Table, and following the procedure from the O.R. Table to PACU.

Patient transfer / repositioning / boosting can be facilitated before and / or after the procedure where the patient's weight might place staff at risk for injury.

The Air Assist Power-Lift inflates the Air-Assist to cushion and cradle the patient, while air simultaneously escapes from the holes on the underside, reducing the force needed to transfer and move a patient to or from the operating room table.

INDICATIONS

- Patients who are unable to assist in lateral transfer, repositioning and / or boosting. Patients who are unable to assist in lateral transfer, repositioning and / or boosting.
- Patients whose weight or girth poses a potential health risk for the caregiver(s) responsible for repositioning and/or laterally transferring said patient.

CONTRAINDICATIONS

- This device is not designed, sold, or intended for use except as indicated.

KNOWLEDGE AND INTENDED SETTING

- Professional use requires knowledge of these instructions for use. Device use limited to surgical operating room setting in a hospital or surgery center.

INTENDED CARE SETTINGS

- Hospitals and Ambulatory Surgery Centers (ASC)

CAUTION

- Never leave the patient unattended when the device is inflated.
- Use this product only for its intended purposes, as described in this manual.
- Only use attachments and/or accessories that are authorized by Xodus Medical.
- Route the power cord in a manner to ensure freedom from hazard.
- Avoid blocking the air intakes of the air supply.
- Avoid electric shock. Do not open air supply.
- Use only the supplied power cord with the unit.
- Verify the operating voltage rating of the Air-Assist Power Lift is compatible with the mains voltage supplied to the electrical outlet prior to operation.
- Power Lift Unit must be turned-off prior to the start of the procedure.
- Do not operate Power Lift Unit intraoperatively.

WARNINGS:

- Before use, make sure the air hose is securely fastened in the Pink Pad Air-Assist inlet
- Air-Assist Power Lift is not for use in the presence of flammable anesthetics or in a hyperbaric chamber or oxygen tent.
- To avoid the risk of electric shock, this equipment must only be connected to a supply main with protective earth.
- The Air-Assist Power Lift is not compatible with DC power supplies.

AIR ASSIST POWER LIFT SPECIFICATIONS:

- Rated Voltage and Current:
 - » 40685: 120VAC; 9.6A; rated power 1200W
 - » 40686: 220VAC; 5.6A; rated power 1200W



Air-Assist Power Lift

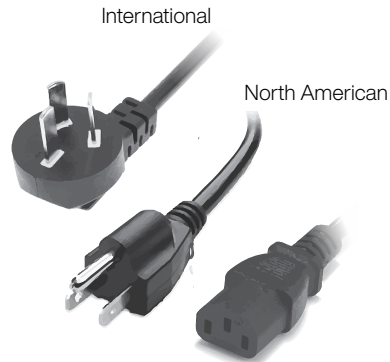

Power Cables



Air Hose



Assembled Unit

ADJUSTABLE:

- For use with Xodus Medical Pink Pad Air-Assist positioning devices. There are 11 settings of air adjustment from 0-10 using the Air Flow Setting Dial. 0 is the lowest setting for minimal airflow and 10 is the maximum setting for maximum airflow. If necessary, the Air-Assist Power Lift is able to be set at any given level of airflow based on user needs. See Figure 1.

- » Air flow ratings at settings:
 - * Setting 0 (minimum): $1.1\text{m}^3/\text{min} \pm 15\%$
 - * Setting 10 (maximum): $2.3\text{m}^3/\text{min} \pm 15\%$

FUSED POWER INPUT:

- The input power to the Air-Assist Power Lift has a protection fuse at the input of the power circuit. This fuse acts as a safety mechanism in the event of over-current (200%) at the power input to the Air-Assist Power Lift unit. This fuse is rated at 12A; 250V. The fuse is removable using a slotted screwdriver to remove the fuse holder. See Figure 1.

LED POWER INDICATOR:

- The Air-Assist Power Lift is equipped with an LED power indicator. When the power is applied to the unit, the LED indicator is illuminated green in color. When no power is applied to the unit, there is no illumination of the power indicator. See Figure 1

Figure 1

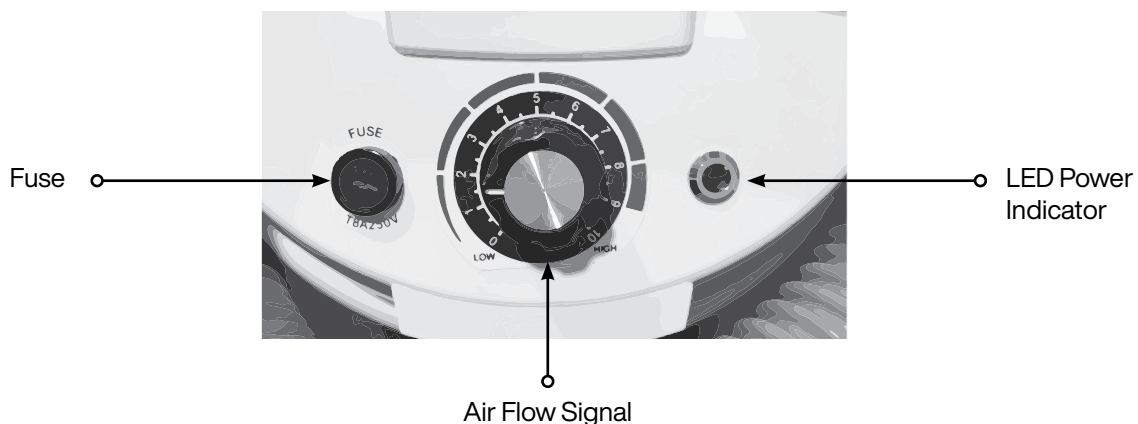

GROUNDING POWER PLUG:

- The power cord for the Air Assist Power Lift is sixteen (16) feet in length and equipped with a grounded female end plug and male end plug. The power cord female end plug is designed to mate with the grounded male plug port receptacle on the Power Lift unit. The power cord male end designed to be plugged into a grounded electrical outlet. See Figure 2.
- The Power Lift is equipped with a power cord locking bracket for additional safety to secure the power cord in the power plug receptacle of the Air-Assist Power Lift unit. See Figure 3.

Figure 2

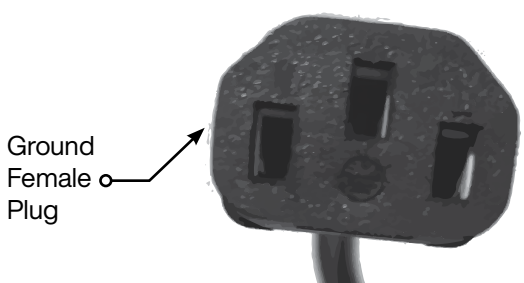
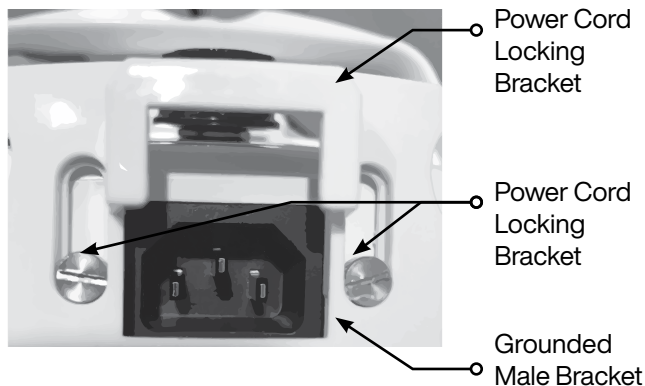

Figure 3



ON/OFF POWER BUTTON:

- The power to the unit is toggled on and off by depressing the button on the top of the unit. Make sure to have the power cord plugged into a grounded outlet, air flow setting at the desired output, the air hose connected to the Power Lift unit, and the air hose secured into the Air-Assist mattress prior to turning on the unit. The green LED light will be illuminated when the unit power button is in the “on” position. See Figure 4.

Figure 4

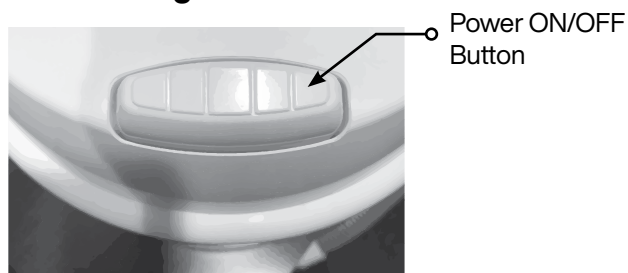

AIR INLET PORTS:

- The Air-Assist Power lift is equipped with eight filtered air inlet ports that are approximately 1” in diameter. These ports are located at the bottom of the housing and equally spaced around the circumference of the unit. Assure these air inlet ports are not blocked prior to operation of the unit. See Figure 5.

Figure 5

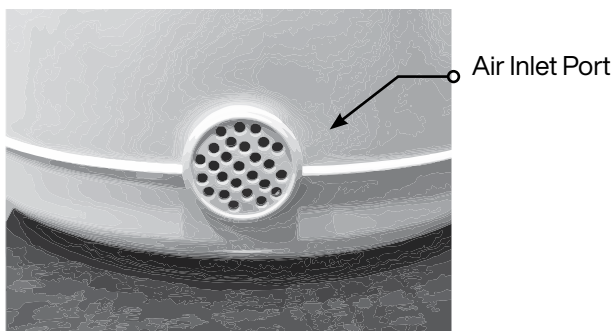

AIR EXHAUST PORT:

- The unit is equipped with an air exhaust port on top of the unit to which the air hose is connected. Make sure the air exhaust is free from any debris prior to connecting the air hose. See Figure 6.

Figure 6

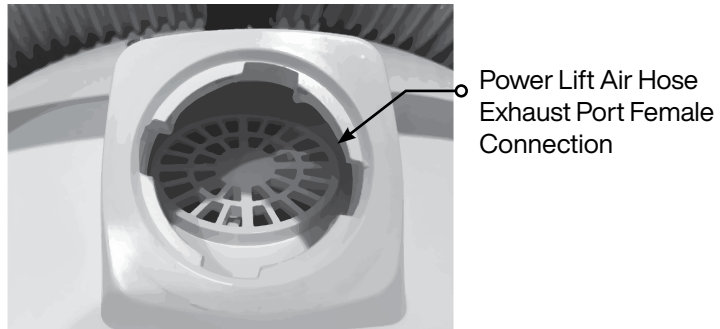

AIR HOSE:

- The air hose provided with the unit is approximately five (5) feet in length. At one end of the hose is a notched male connector. This connector is used to connect the air hose to the Air-Assist Power Lift unit at the air exhaust connector. See Figure 7.

Figure 7

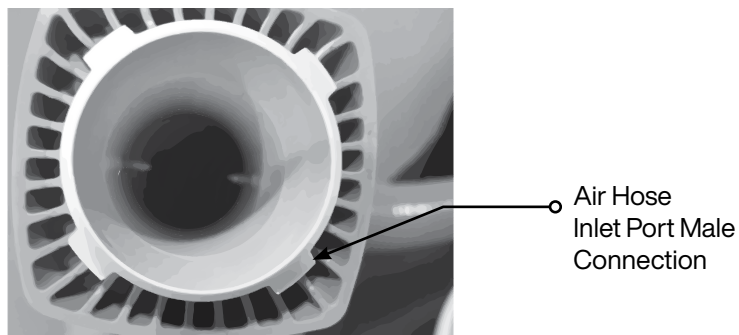

- The opposite end of the air hose is equipped with a male exhaust duct connector with a male button snap. This end is used to insert into the female port of the Air-Assist mattress for inflation. See Figure 8.

Figure 8

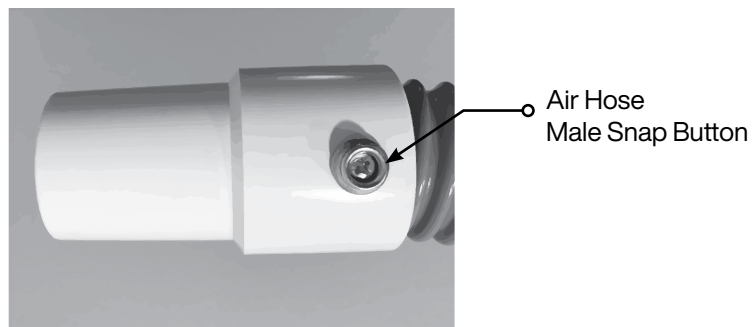

PREPARING THE AIR-ASSIST POWER LIFT FOR OPERATION:

AIR HOSE:

1. Locate the notched male end of the air hose.
2. Locate the female notched air output port on the unit.
3. Align the male hose end with the female air output port insuring the male notches of the air hose align with the female notches of the air outlet port.
4. Insert the air hose into the air outlet port of the unit.
5. Turn the air hose in a counter-clockwise direction until it stops. Once it stops, this is considered fully locked in place.
6. Locate at the opposite end of the air hose, the male duct connector is equipped with the male button snap.
7. Locate the appropriate female air inlet port on the Air-Assist mattress.
8. Loosen the hook strap on the Air-Assist mattress air inlet port.
9. Insert the male duct connector with the male button snap into the female air inlet port on the Air-Assist mattress.
10. Align the male button snap with the female button snap found on the hook strap.
11. Snap the male button fully into the female button.
12. Pull the hook strap back to its original position assuring a snug fit around the distal end of the air hose inserted into the Air-Assist air inlet port.

POWER CORD:

1. Lift the Power Cord Locking Bracket fully upward.
2. Insert the female end of the grounded power cord into the male grounded port on the unit
3. Once fully inserted, pull down the Power Cord Locking Bracket back to its original position over the female end of the power cord.
4. Locate the two slotted screws in the Power Cord Locking Bracket.
5. Tighten each screw sufficiently to prevent movement of the Power Cord Locking Bracket. Do not over-tighten.
6. Verify the voltage rating of the Air-Assist Power Lift matches the mains voltage. Plug the male end of the power cord into the corresponding electrical outlet. Make sure the plug is fully inserted in the outlet.

OPERATION:

1. Once all connections have been made to the Air-Assist Power Lift, the Air-Assist mattress, and electrical outlet, proceed to verify the air flow setting designated flow setting.
2. Once the setting has been verified, press the power button at the top of the Air-Assist Power Lift to provide power to the unit.
3. Once the Air-Assist mattress is inflated initially, the air flow setting may be adjusted, as necessary, up or down depending upon desired outcomes.
4. Once the patient has been moved and in position, the power button on the top of the Air-Assist Power Lift is depressed to cut power to the unit.
5. Once the mattress is deflated, proceed to disconnect the air hose from the Air-Assist mattress. Also, disconnect the electrical plug from the electrical outlet.
6. Gather the power cord and the air hose and store the Air-Assist Power Lift in a safe location.

PRODUCT SPECIFICATIONS

DIMENSIONS	13"(H) x 9.5"(W) (33cm x 24.1cm)
WEIGHT	9.25lbs (4.2kg)
ENCLOSURE MATERIAL	ABS
POWER CORD LENGTH	16 feet (5m)
AC PLUG CORD TYPE	40685: Male Type B; Female IEC13 40686: Male Type I; Female IEC 13
POWER INPUT	40685: 120VAC 60Hz 9.6A (North American) 40686: 220VAC 50HZ 5.5A (International)
POWER RATING	1200W
POWER CORD	16A; 250V
FUSE	12A; 250V
AIR HOSE LENGTH	5 feet (1.5m)
RATED POWER	1100w
OPERATING ENVIRONMENT	32°F to 104°F (0°C to 40°C); 25% to 90%RH; 80kPa to 110kPa

CLASSIFICATION:

Type of protection against electric shock: CLASS I EQUIPMENT
Degree of protection against electric shock: TYPE BF APPLIED PART
Protection against ingress of water: IPX0 Ordinary (not protected).
COMPLIES WITH IEC 60601-1, 60601-1-2

CLEANING:

Between patient use, clean and disinfect the surface of the air supply by wiping it down with EPA approved hospital-grade disinfectant wipes or disinfectant cleaner sprayed on a cleaning cloth prior to wiping the unit. Follow disinfectant manufacturer's directions for dwell time and other instructions for use. Do not spray cleaners or liquids directly on the unit.

PREVENTIVE MAINTENANCE:

Prior to use, a visual inspection should be performed on the air supply to ensure the power cord is not frayed or nicked and that there is no visual damage that would render the air supply unusable.

The air supply has an air filter between the air inlet ports and the motor. This filter can be accessed by removing the small screws holding the filter covers in place. It is recommended that the air filter is assessed per your facility's preventive maintenance schedule or annually.

Filter should be cleaned if clogged.



Remove the filter from the air supply and hold it under warm running water. Allow the air filters to dry prior to placing back in the air supply.



The filter should be replaced when it is clogged with debris that does not break free when it is washed.



The filter should also be replaced if it begins to lose its shape or deteriorate.

NOTE: IF AIR SUPPLY NEEDS TO BE DISPOSED, CHECK YOUR LOCAL / STATE / FEDERAL / INTERNATIONAL GUIDELINES BEFORE DISPOSAL.

Symbol Glossary

 <small>xodusmedical.com/eifu</small>	Consult electronic instructions for use
	Manufacturer
	Humidity limitation

	Protective Earth
	Alternating Current
	Temperature Limitation

	Caution
	Keep Dry
	Type BF applied part



LITIFUAA003 R1 8/31/2023

702 Prominence Drive | Pittsburgh, PA 15068 U.S.A.

Tel: 724.337.5500
Fax: 724.337.0555

xodusmedical.com
info@xodusmedical.com

FDA REGISTERED
ISO 13485 CERTIFIED